

MOUNTING SLOTS COMPATIBLE WITH BREADBOARDS WITH 50mm OR 2in HOLE SPACING

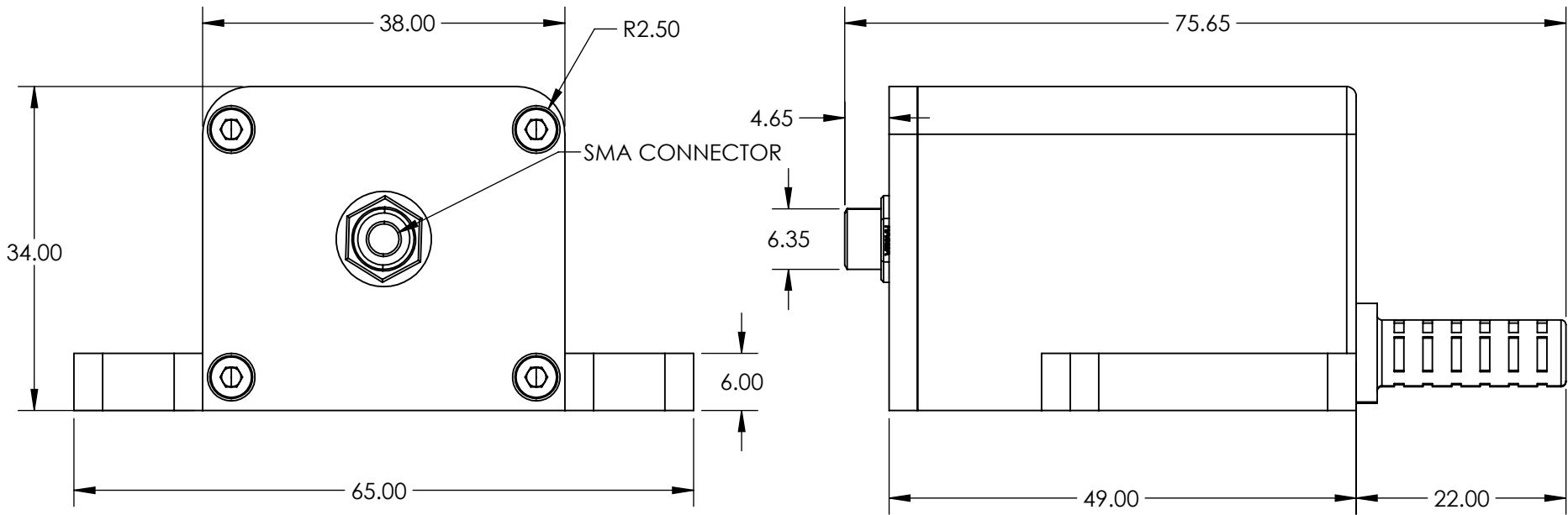
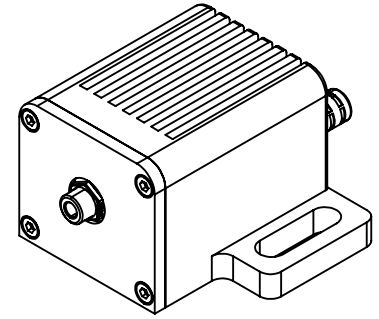

**FOR INFORMATION ONLY:
DO NOT MANUFACTURE
PARTS TO THIS DRAWING**

SPECIFICATIONS SUBJECT TO CHANGE WITHOUT NOTICE
DIMENSIONS ARE FOR REFERENCE ONLY

EO® Edmund Optics®

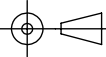
THIRD ANGLE PROJECTION 		TITLE	880nm, 1mW, 1000mA, SMA Connector, Fiber-Coupled LED	
ALL DIMS IN	mm	DWG NO	23742	SHEET 16 OF 18